



www.FGWilson.com

P500-5



Image for illustration purposes only.

Output Ratings

Voltage, Frequency	Prime	Standby
380/220 V, 50 Hz	455.0 kVA / 364.0 kW	500.0 kVA / 400.0 kW
	- / -	- / -

Ratings at 0.8 power factor.

Please refer to the output ratings technical data section for specific generator set outputs per voltage.

Prime Rating

These ratings are applicable for supplying continuous electrical power (at variable load) in lieu of commercially purchased power. There is no limitation to the annual hours of operation and this model can supply 10% overload power for 1 hour in 12 hours.

Standby Rating

These ratings are applicable for supplying continuous electrical power (at variable load) in the event of a utility power failure. No overload is permitted on these ratings. The alternator on this model is peak continuous rated (as defined in ISO 8528-3).

Standard Reference Conditions

Note: Standard reference conditions 25°C (77°F) Air Inlet Temp, 100m (328 ft) A.S.L. 30% relative humidity.
Fuel consumption data at full load with diesel fuel with specific gravity of 0.85 and conforming to BS2869: 1998, Class A2.

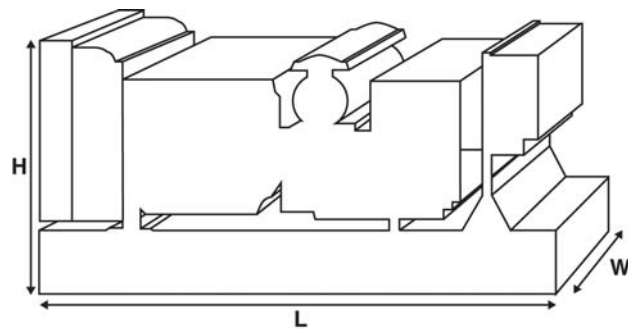

Ratings and Performance Data

Engine Make & Model:	Perkins 2506A-E15TAG1	
Alternator manufactured for FG Wilson by:	WEG	
Alternator Model:	GTA 312 AE49	
Control Panel:	PowerWizard 1.1+	
Base Frame:	Heavy Duty Fabricated Steel	
Circuit Breaker Type:	3 Pole MCCB	
Frequency:	50 Hz	60 Hz
Engine Speed: rpm	1500	-
Fuel Tank Capacity: litres (US gal)	888 (234.6)	
Fuel Consumption: l/hr (US gal/hr)		
(100% Load)	- Prime	94.9 (25.1) -
	- Standby	104.1 (27.5) -

Available Options

FG Wilson offer a range of optional features to tailor our generator sets to meet your power needs. Options include:

- Upgrade to CE Certification
- A wide range of Sound Attenuated Enclosures
- A variety of generator set control and synchronising panels
- Additional alarms and shutdowns
- A selection of exhaust silencer noise levels

For further information on all of the standard and optional features accompanying this product please contact your local Dealer or visit: www.FGWilson.com

Dimensions and Weights

Length (L)	Width (W)	Height (H)	Dry	Wet
mm (in)	mm (in)	mm (in)	kg (lb)	kg (lb)
3800 (149.6)	1131 (44.5)	2215 (87.2)	3717 (8195)	3775 (8322)

Dry = With Lube Oil

Wet = With Lube Oil and Coolant

Ratings in accordance with ISO 8528, ISO 3046, IEC 60034, BS5000 and NEMA MG-1.22. Generator set pictured may include optional accessories.

Engine Technical Data	
No. of Cylinders / Alignment:	6 / In Line
Cycle:	4 Stroke
Bore / Stroke: mm (in)	137.0 (5.4)/171.0 (6.7)
Induction:	Turbocharged Air To Air Charge Cooled
Cooling Method:	Water
Governing Type:	Electronic
Governing Class:	ISO 8528 G2
Compression Ratio:	16.0:1
Displacement: l (cu. in)	15.2 (927.6)
Moment of Inertia: kg m ² (lb/in ²)	4.29 (14660)
Engine Electrical System:	
- Voltage / Ground	24/Negative
- Battery Charger Amps	70
Weight: kg (lb)	
- Dry	1633 (3600)
- Wet	1714 (3779)

Performance	50 Hz	60 Hz
Engine Speed: rpm	1500	-
Gross Engine Power: kW (hp)		
- Prime	412.0 (553.0)	-
- Standby	451.0 (605.0)	-
BMEP: kPa (psi)		
- Prime	2235.0 (316.1)	-
- Standby	2447.0 (346.0)	-

Fuel System				
Fuel Filter Type:	Replaceable Element			
Recommended Fuel:	Class A2 Diesel or BSEN590			
Fuel Consumption: l/hr (US gal/hr)				
	110%	100%	75%	50%
Prime	Load	Load	Load	Load
50 Hz	104.1 (27.5)	94.9 (25.1)	73.0 (19.3)	52.4 (13.8)
60 Hz	-	-	-	-
	100%	75%	50%	
Standby	Load	Load	Load	
50 Hz	104.1 (27.5)	79.4 (21.0)	56.5 (14.9)	
60 Hz	-	-	-	

(Based on diesel fuel with a specific gravity of 0.85 and conforming to BS2869, Class A2)

Air Systems	50 Hz	60 Hz
Air Filter Type:	Non Canister	
Combustion Air Flow: m ³ /min (cfm)		
- Prime	25.8 (911)	-
- Standby	30.5 (1077)	-
Max. Combustion Air Intake Restriction: kPa (in H ₂ O)	6.2 (24.9)	-

Cooling System	50 Hz	60 Hz
Cooling System Capacity: l (US gal)	58.1 (15.3)	-
Water Pump Type: Centrifugal		
Heat Rejected to Water & Lube Oil:		
kW (Btu/min)		
- Prime	134.0 (7620)	-
- Standby	147.0 (8360)	-
Heat Radiation to Room: Heat radiated from engine and alternator		
kW (Btu/min)		
- Prime	55.4 (3151)	-
- Standby	63.2 (3594)	-
Radiator Fan Load: kW (hp)	13.7 (18.4)	-
Radiator Cooling Airflow: m ³ /min (cfm)	476.4 (16824)	-
External Restriction to Cooling Airflow: Pa (in H ₂ O)	125 (0.5)	-

Designed to operate in ambient conditions up to 50°C (122°F). Contact your local FG Wilson Dealer for power ratings at specific site conditions.

Lubrication System	
Oil Filter Type:	Eco, Full Flow
Total Oil Capacity: l (US gal)	62.0 (16.4)
Oil Pan: l (US gal)	53.0 (14.0)
Oil Type:	API CI4 15W-40
Oil Cooling Method:	Water

Exhaust System	50 Hz	60 Hz
Maximum Allowable Back Pressure: kPa (in Hg)	6.8 (2.0)	-
Exhaust Gas Flow: m ³ /min (cfm)		
- Prime	71.4 (2521)	-
- Standby	81.0 (2860)	-
Exhaust Gas Temperature: °C (°F)		
- Prime	500 (932)	-
- Standby	550 (1022)	-

Documentation

A full set of operation and maintenance manuals and circuit wiring diagrams.

Generator Set Standards

The equipment meets the following standards: BS5000, ISO 8528, ISO 3046, IEC 60034, NEMA MG-1.22.

FG Wilson is a fully accredited ISO 9001 company.

Warranty

All prime equipment carries a one year manufacturer's warranty. Standby equipment, limited to 500 running hours per year, has a two year manufacturer's warranty. For details on warranty cover please contact your local Dealer, or visit our website: FGWilson.com.

Dealer contact details:

FG Wilson manufactures product in the following locations:

Northern Ireland • Brazil • China • India • USA

With headquarters in Northern Ireland, FG Wilson operates through a Global Dealer Network.

To contact your local Sales Office please visit the FG Wilson website at www.FGWilson.com.

FG Wilson is a trading name of Caterpillar (NI) Limited.